

Part 1

Animals

practice question

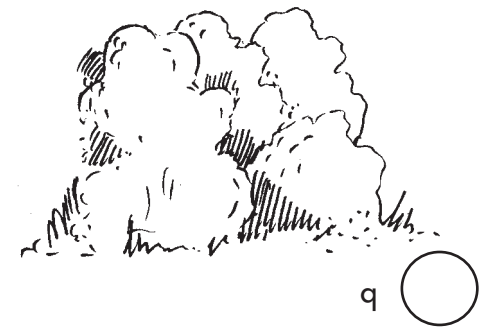
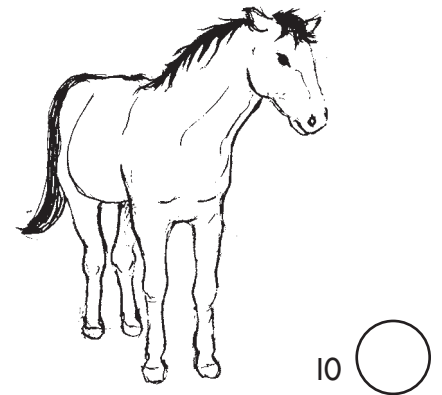
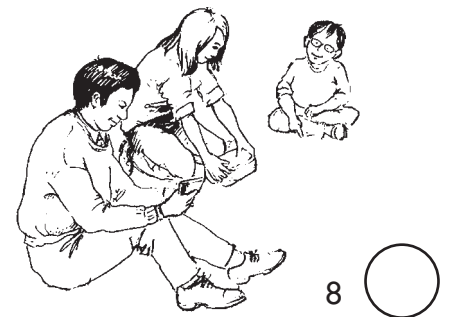
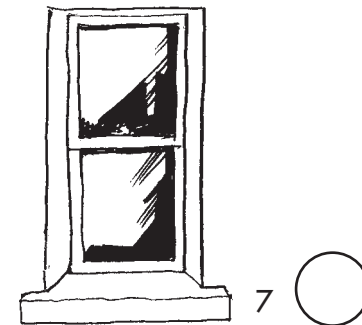
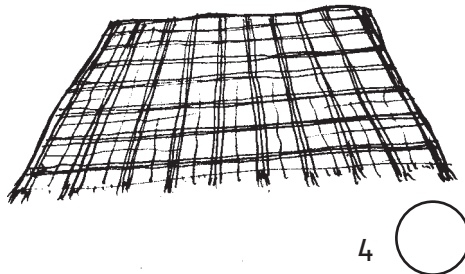
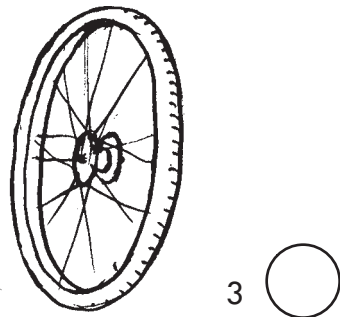
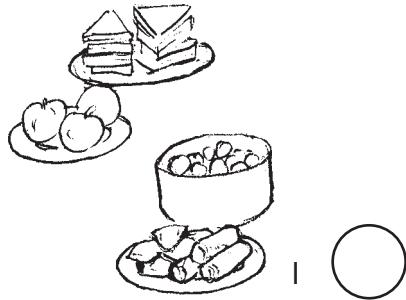

Part 2

How the Camel got his hump

There was once a Camel who lived in the middle of a _____
 desert. He did not want to work. So he just ate _____ and
 thorns. When anybody _____ to him he said 'Humph!'
 Just 'Humph!' and no more.

On Monday the Pony came to him with a saddle on his back. He
 said 'Camel, oh Camel, come out and _____ like the rest
 of us.' 'Humph!' said the Camel and the Pony went away.

On _____ the Dog came to him with a twig in his
 mouth. He said 'Camel, oh Camel, come and _____ and
 _____ like the rest of us.' 'Humph!' said the Camel and
 the Dog _____ off.

The Pony and the Dog had to work harder _____ the
 Camel would not work.

On Wednesday the man who was in charge of all the animals went
 to see the Camel. He said 'You have _____ the other
 two extra work since Monday.' 'Humph!' said the Camel.

'I wouldn't say that again' said the man. 'Humph!' said the Camel
 again.

But no sooner had he said it than he saw his back puffing up into a
 great big hump. And ever since that day, the Camel always
 wears a hump. We call it a 'hump' now, not to hurt his
 _____.

practice

11

12

13

14

15

16

17

18

19

20

Animals

Spelling Sheet

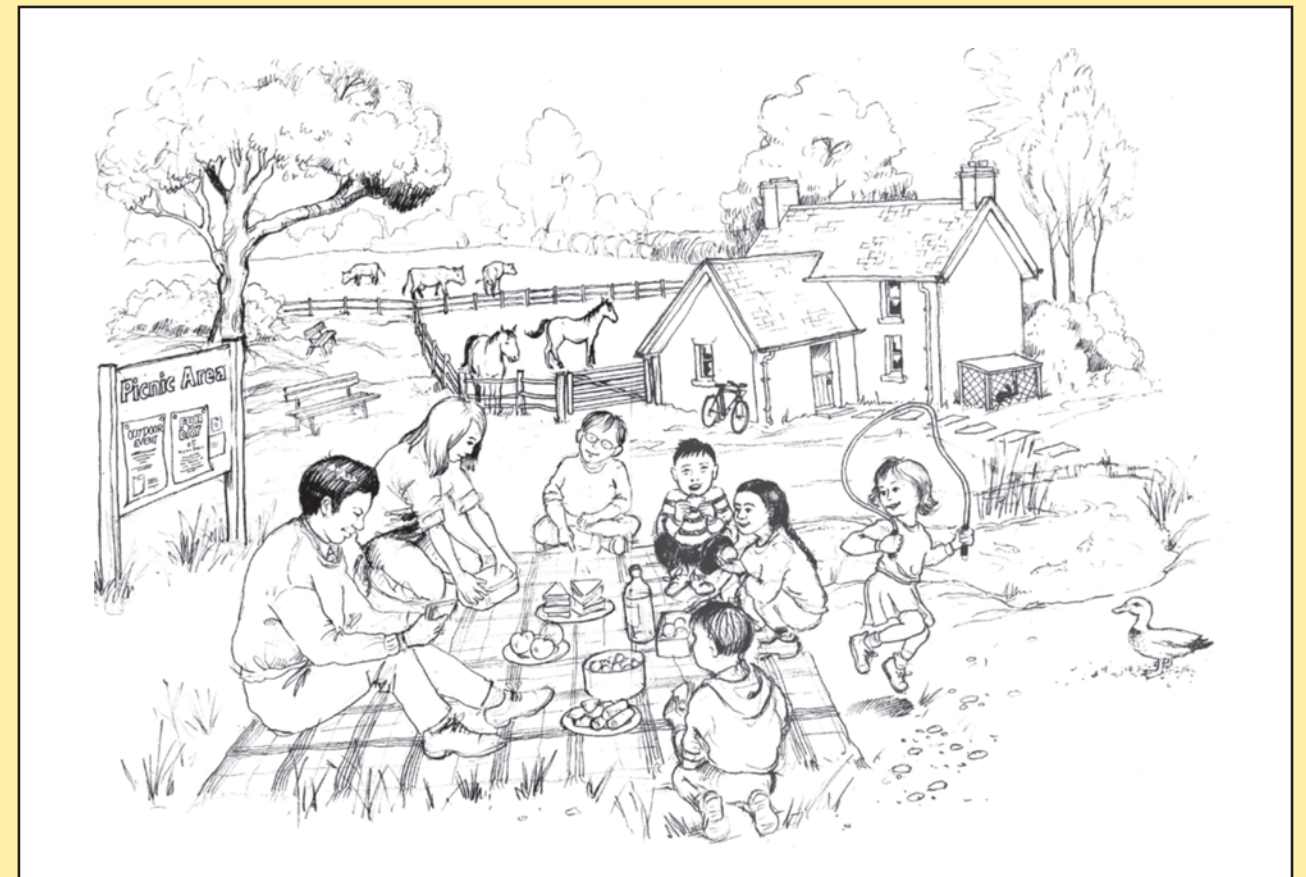

Name

Total words correct

Spelling mark awarded

Number of words correct			Mark awarded
0			0
1	2	3	1
4	5	6	2
7	8	9	3
10	11	12	4
13	14	15	5
16	17	18	6
19	20		7

Illustrations by David Leithead.
 Adapted from 'How the Camel Got his Hump'
 by Rudyard Kipling in *The Puffin Book of Stories*
 for Seven-Year-Olds edited by Wendy Cooling.
 Puffin Books (1996). ISBN: 0-14-037460-4.

This text has been incorporated into this test paper solely for the purposes of the examination in
 accordance with Section 32(3) of the Copyright, Designs and Patents Act 1988. No copyright clearance
 for any other use has been obtained or sought. © Qualifications and Curriculum Authority (QCA) 2007.